

THINK > Filter Technology



SIKA-R... AX



Since 1759

> 250 years of exceptional engineering

GKN Sinter Metals Filters, the leading manufacturer of porous sinter metal products, offers a variety of solutions to fulfil customer requirements.

We are familiar with various applications in almost every industrial branch.

Our products are applied in gas- and liquid filtration, dampening, sparging, sensor protection, bulk handling and many more. We offer solutions for high temperature and corrosive environments.

Sintered filter elements made of stainless steels, bronze, nickel based alloys, titanium and several special alloys can be manufactured seamless up to 1,600 mm length and 320 mm OD. Larger elements will be assembled in our certified in-house welding shop.

Our most innovative product for the chemical industry is the patented metallic membrane SIKA-R...AS.

The filter cartridges equipped with this state-of-the-art technology offer a flow rate up to 4 times higher compared to conventional sinter metal filter cartridges. Furthermore an excellent back flush performance is guaranteed. The filter active membrane layer with filter grades down to 0.1 µm absolute has a thickness of only 200 µm and is made of the same alloy as the coarse support material. The membrane is sinter bonded to the support and therefore cannot peel off.

Another innovation introduced by GKN is the sinter bonded joint of porous parts with solid fittings in order to avoid welding seams – the weak spot of all sintered cartridges of our competitors.

All sintered materials of GKN offer a self-supporting structure with high mechanical strength.

We manufacture various filter grades with specified pore sizes and flow rates in order to have the appropriate solution for your requirements.



SIKA-R...AX is the brand name of GKN Sinter Metals' high porous stainless filter elements manufactured by coaxial compaction

SIKA-R...AX materials are used as self-supporting structural elements. The pores are mechanically fixed regarding size and position after the sintering process.

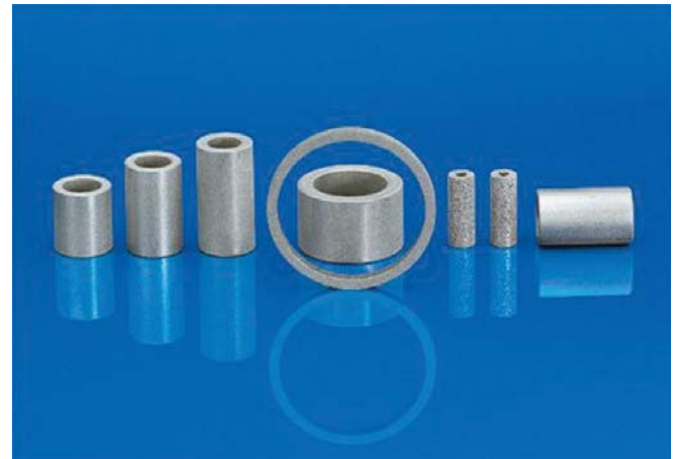

Properties

These characteristics of SIKA-R...AX products go along with the following important properties:

- Shape/-stability i.e. selfsupporting structural elements suitable for high differential pressures
- Particularly good properties when under compression, vibration and changing conditions or with high sudden pressures peaks
- High heat resistance and thermal stability
- Defined permeability and filtration properties because the pore size and distribution are exact and uniform
- Backflushing and easy cleaning with supersaturated superheated steam, chemical solvents, thermal and ultrasonic processes
- The variety of materials used can be welded and machined



Application Examples

- Autogenous welding (as flame arrestors) / Explosion protection
- Polymer filtration
- Gas- and Liquid filtration
- Silencing
- Sparging
- Fluidization (handling of bulk material)
- Sensor and valve protection
- Flow restriction

As well as various applications in industries like

- Chemical
- Food / Beverage
- Semiconductor
- Scientific Instrumentation
- Pharmaceutical

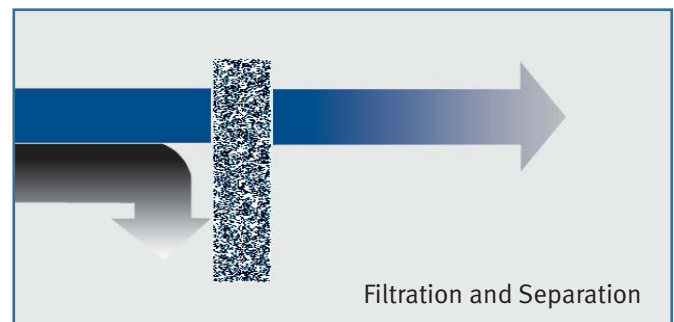
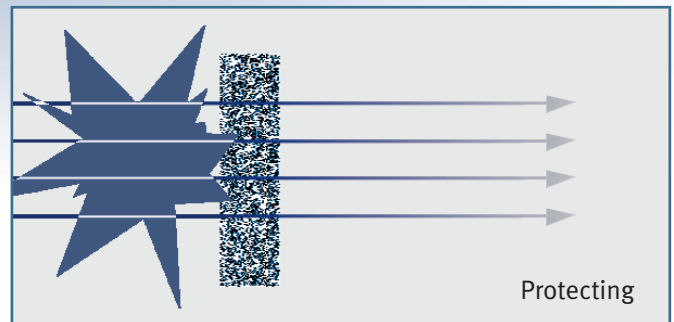

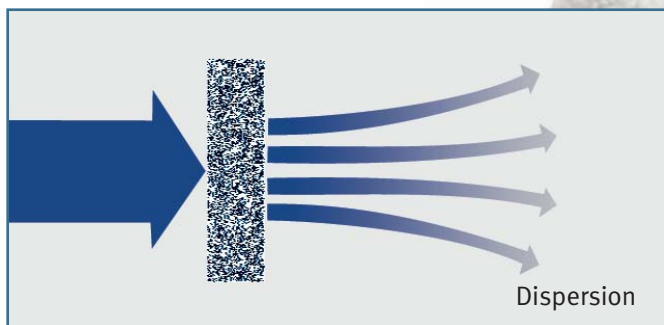

Various forms of sensor protection





Manufacturing of SIKA-R...AX Products

Pressing process

SIKA-R...AX filter elements are formed by co-axial pressing.

The metal powder is filled into the appropriate die and compacted in axial direction by upper and lower punch. The pore size of the finished product can be controlled by the choice of powder size and the pressing force used to form the part.

A wide range of finished shapes can be achieved by this pressing process.

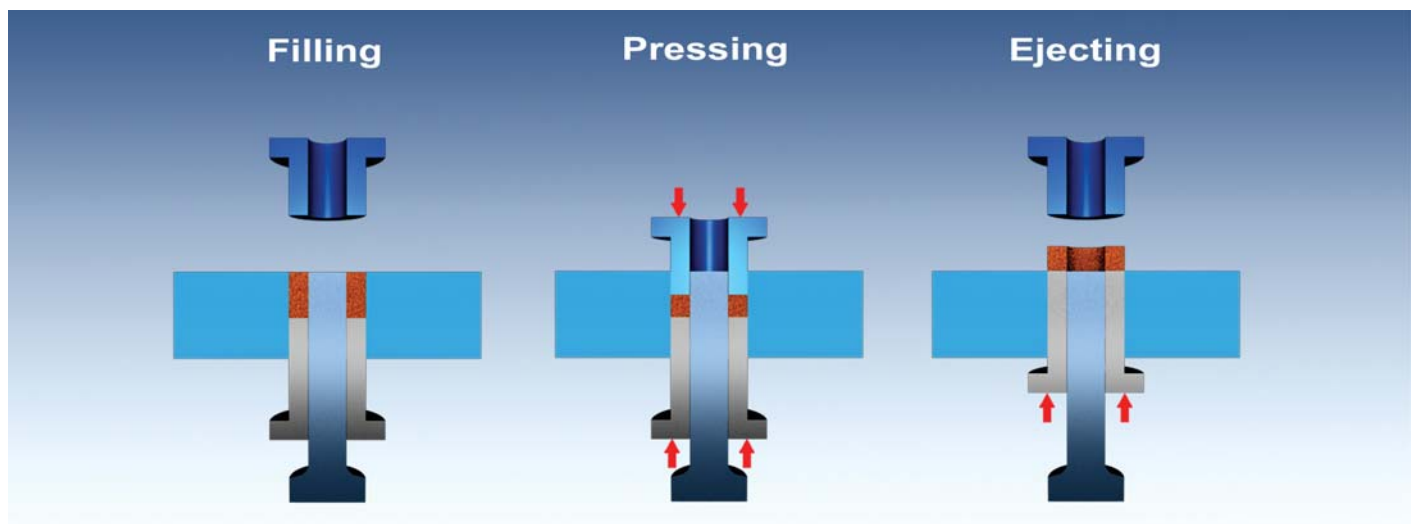



Sintering

The compacted part is sintered in specially designed furnaces. Sintering is the fundamental processing step for all Powdered Metal (P/M) products. It is the process of bonding the powder particles by fusing them together at temperatures well below their melting point.

After sintering, regardless of micron size, the separate grain structure of the original powdered metal becomes fully interlinked to form a rigid part.

Sintering gives the high porous material the shape stability and property of a strong metal component.

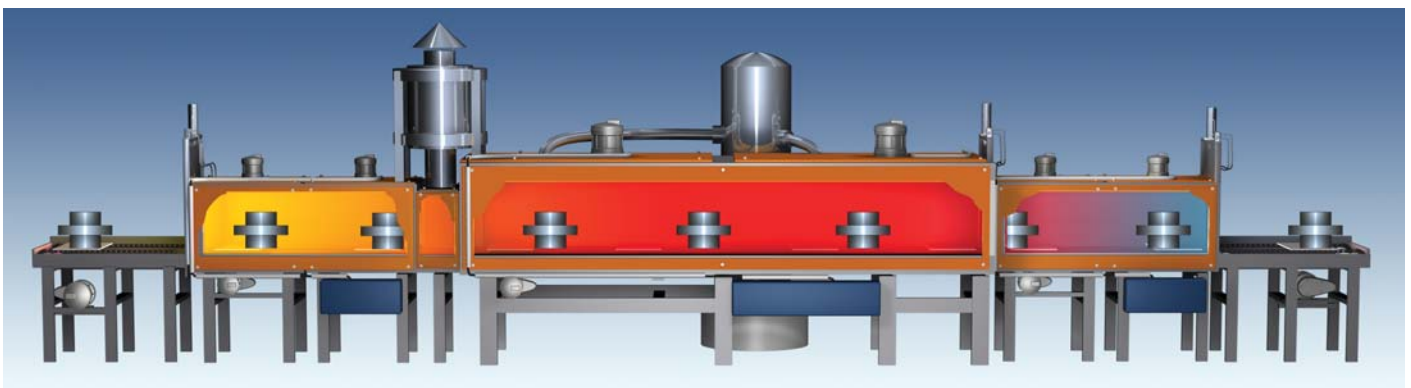

Burn-out of lubricant

Sintering

Cooling

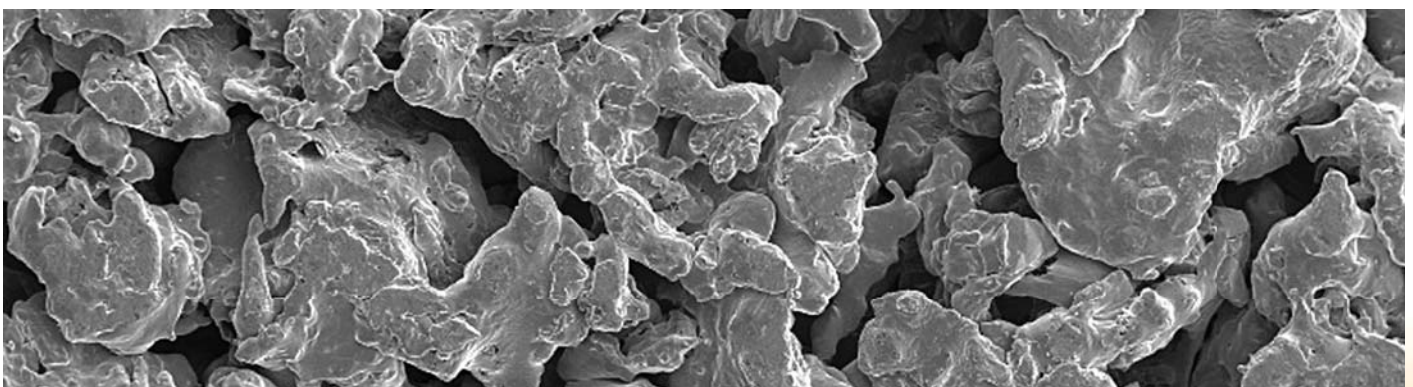



Standard Materials

Material	Name	Mat.-No.	SIKA-				Fe	Cr	Ni	C	Mo	Miscellany	Max. Temperature °C		Keyword
			R...	FIL	B								Reducing	Oxidizing	
			IS	AX	AS	in weight-%									
High alloyed material	AISI 304 L	1.4306	x	x	x		Bal.	18.0-21.0	8.0-12.0	≤0.03	0.5	N≤0.1	600	500	Standard for food application
	AISI 316 L	1.4404	x	x	x		Bal.	16.0-18.0	10.0-14.0	≤0.03	2.0-3.0	N≤0.1	540	400	
						x							380	320	
	AISI 904 L	1.4539	x	x	x		Bal.	19.0-21.0	24.0-26.0	≤0.02	4.0-5.0	N≤0.15 Cu 1.2-2.0	600	500	Resistant against sulphuric acid, phosphoric and hydrochloric acid
	AISI 310	1.4841				x	Bal.	24.0-26.0	19.0-22.0	≤0.25	-	-	800	600	Heat resistant
FeCrAl	1.4767 Mod.				x	Bal.	19.0-22.0	-	<0.10	-	Al 5.0-6.5 with rare earth elements	unfit	1000		
Nickel based alloys*	Hastelloy C 22	2.4602	x				2.0-6.0	20.0-22.5	Bal.	<0.02	12.0-14.5	W 2.0-3.5 Co 2.5	650	650	Corrosion resistant with various aggressive media. Duration application at > 400 °C possible.
	Hastelloy C 276	2.4819	x	x			4.0-7.0	14.0-16.0	Bal.	<0.02	15.0-17.0	W 3.0-4.5	650	650	
	Hastelloy X	2.4665	x	x			17.0-20.0	20.5-23.0	Bal.	<0.15	8.0-10.0	Co 0.5-2.5 W 0.2-1.0	930	800	
	Inconel 600	2.4816	x	x	x		6.0-10.0	14.0-17.0	≥72.0	<0.15	-	-	700	600	
	Inconel 625	2.4856	x		x		≤5.00	20.0-23.0	≥58.0	<0.10	8.0-10.0	Nb 3.15-4.15	650	650	
	Monel 400	2.4360	x	x	x		<2.0	-	≥63.0	<0.30	-	Cu 28.0-34.0	500	500	Resistant against Cl-containing media
Bronze**	CuSn 11	2.1052					x	-	-	-	-	-	300	250	Typically used for hydraulic & pneumatic
Titanium	Ti	-	x	x				-	-	-	-	Ti > 99 %	500	500	Medicine. acid. electrolysis
Other	Other materials on request														

Not all raw materials are in stock. Typical Iron or Nickel elements e.g. Si, Mn, P, S according to the literature.

* Nickel based AX-products only after consultation. Not all dimensions feasible.

** Nickel plating possible

Elements SIKA-R...AX

Our various high porosity sintered metal filter elements can be manufactured in the following standard geometries:

- Discs
- Cylinders / Open ended
- Cylinders with one closed end
- Plates
- Cones
- Silencer made of stainless steel sintered together with a solid stainless steel thread

Seamless design up to 315 mm diameter.

We also manufacture to customer-specified dimensions.
Bigger elements can be welded at our certified in-house welding shop.

GKN Filter Grades

SIKA-R	0.1	AX
SIKA-R	0.5	AX
SIKA-R	1	AX
SIKA-R	3	AX
SIKA-R	5	AX
SIKA-R	7	AX
SIKA-R	10	AX
SIKA-R	15	AX
SIKA-R	20	AX
SIKA-R	30	AX
SIKA-R	40	AX
SIKA-R	50	AX
SIKA-R	80	AX
SIKA-R	100	AX
SIKA-R	150	AX
SIKA-R	200	AX



Standard Geometries

SIKA-Discs

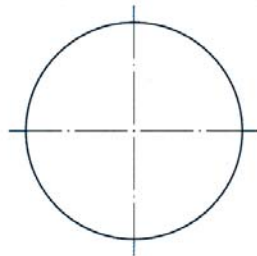
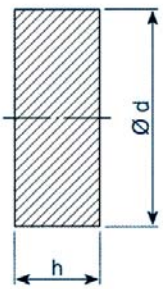

Seamless construction is possible up to 315 mm diameter and 40 mm in height

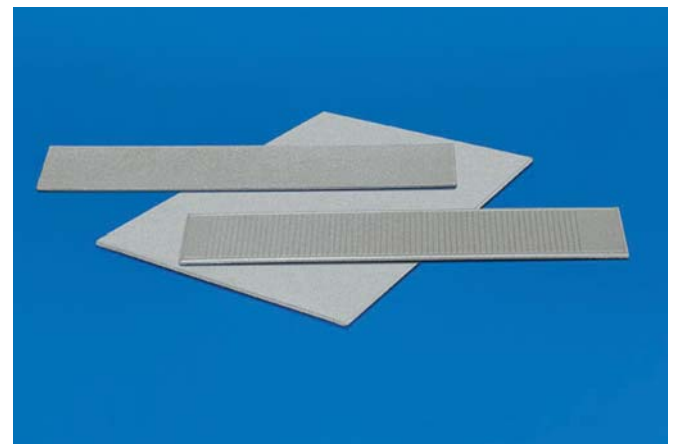
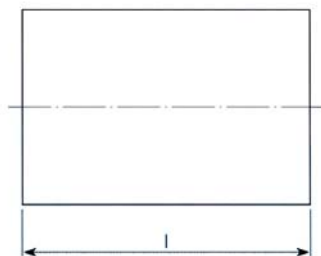
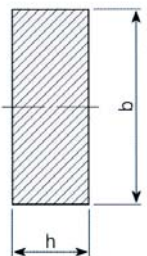

Standard plate size is 200 x 300 mm, height up to 20 mm



Standard Geometries

SIKA-Cylinders / Open ended

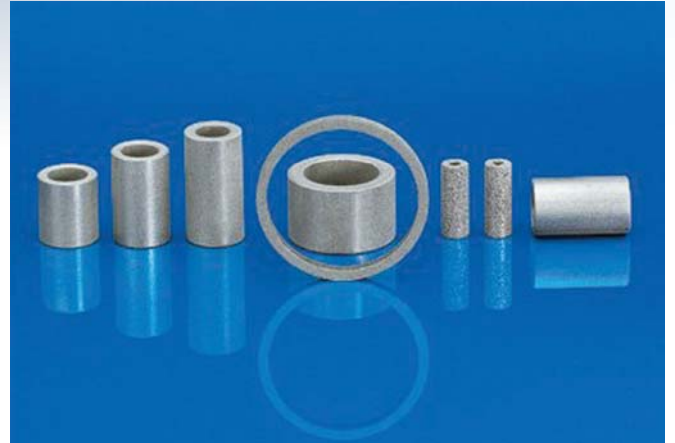
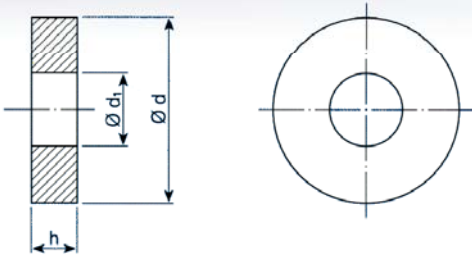

SIKA-Cylinders with one closed end

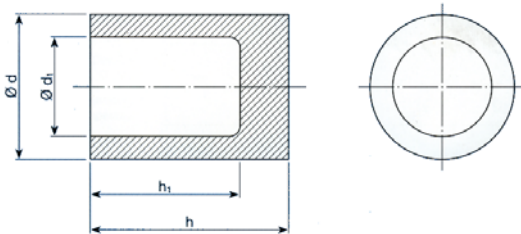

Silencer made of stainless steel sintered together with a solid stainless steel thread

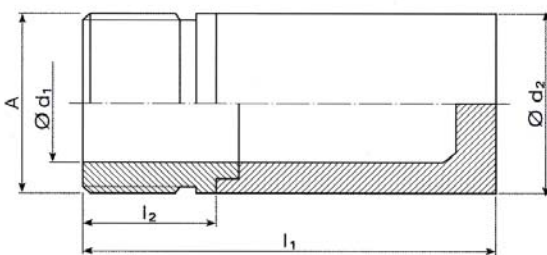



Customer Specific Constructions

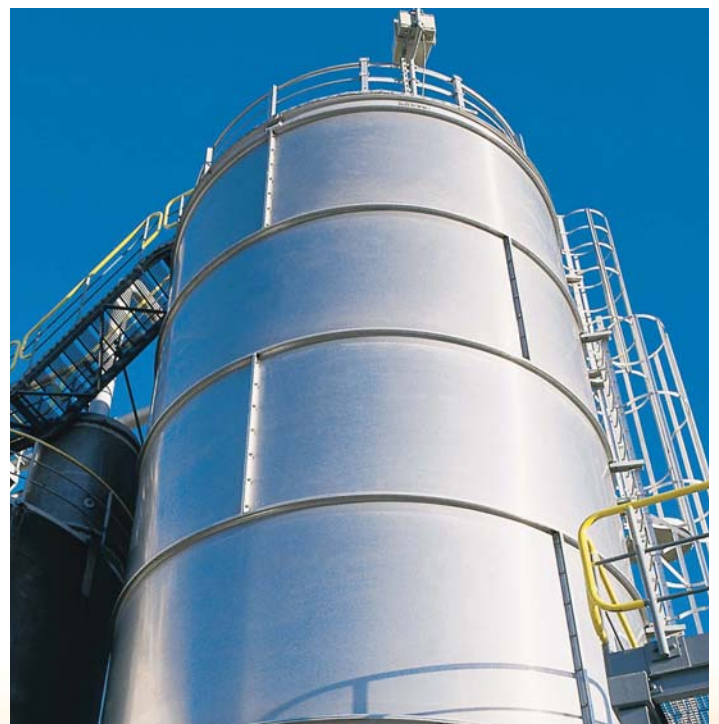
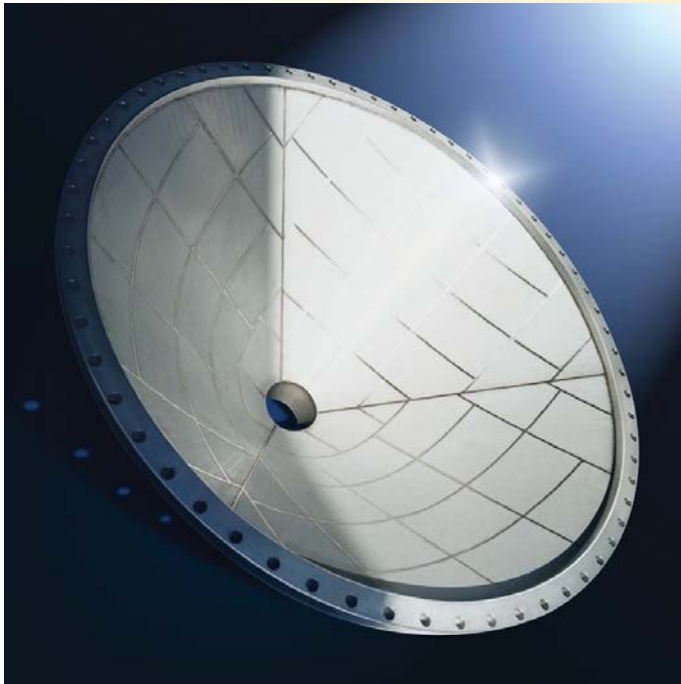



Additional Applications of GKN Filters...

Catalyst recovery



Refinery



Water treatment

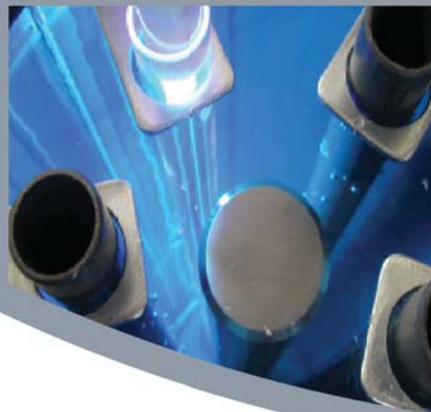



Pneumatic valves



Ex-protection

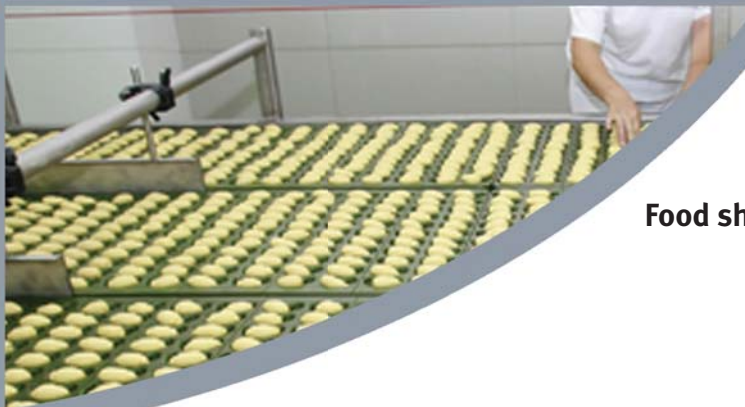

Food shaping



Basic Information for Designing a Filter

Customer's Information

Enquiry date: _____

Company Name _____

Contact Name _____

Street Address _____

ZIP _____

Town, US State _____

Country _____

1. The planned application of the SIKA element?

- | | | |
|----------------------------------|----------------------------------|----------------------------------|
| <input type="radio"/> Filtration | <input type="radio"/> Equalizing | <input type="radio"/> Fluidizing |
| <input type="radio"/> Separation | <input type="radio"/> Silencing | <input type="radio"/> Sparging |
| <input type="radio"/> Throttling | <input type="radio"/> Protecting | <input type="radio"/> Degassing |

Others _____

2. What kind of gas or liquid will flow through the SIKA element?

Medium specification

Operation density _____

Dynamic viscosity _____

Operation temperature _____

Operating flow rate _____

Absolute operating pressure before SIKA-element _____

Wanted or permissible pressure drop of clean filter _____

Max permissible pressure drop of used filter _____

3. Which particles must be retained by a SIKA element?

Description

Filter grade _____

4. How will the SIKA element be applied?

Shape of the element Tube Cartridge Sheet

Disc Other

Connecting element Flange Thread Other

Housing diameter _____

Quantity _____

5. Short description of the process:



Further Brochures Available

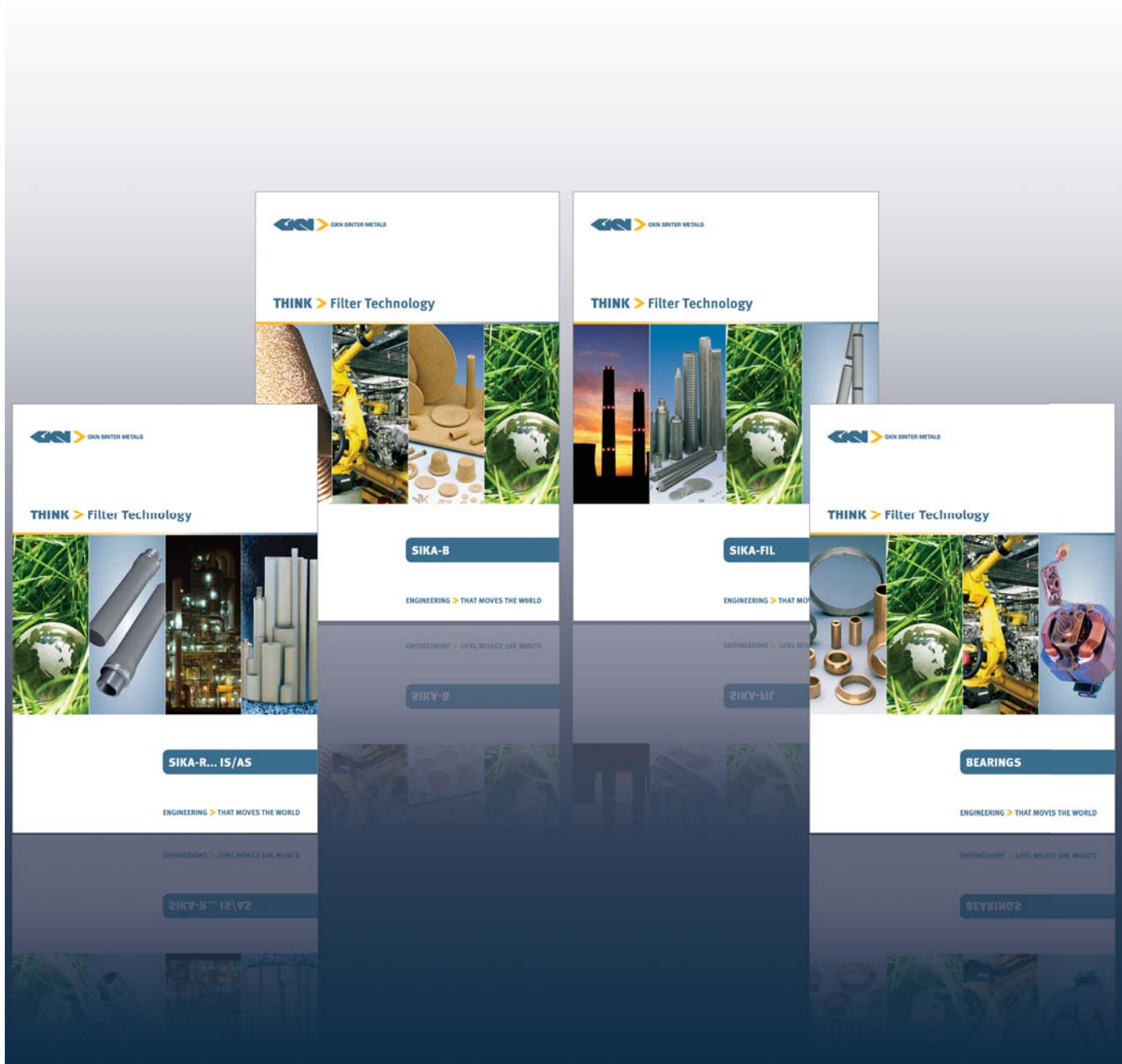



GKN Sinter Metals Filters GmbH

Dahlienstraße 43

D-42477 Radevormwald

P.O. Box 1520

D-42464 Radevormwald

Phone: +49 (0) 2195-609-0

Fax: +49 (0) 2195-609-348

Email: info@gkn-filters.com

www.gkn.com/filters